

# Spyne User's Guide

Version: 1.3 (Magnifi® 4.7)

Date: 2020-05-22

## Table of contents

1. Probe Description .....	3
1a. Spyne scanner .....	3
1b. Spyne scanner accessories.....	4
1c. Spyne probes .....	5
1d. Spyne probe replacement.....	6
2. Magnifi setup .....	7
2a. Preparing the setup .....	7
2b. Setup parameters.....	8
2c. Setup layout.....	9
3. Data management.....	10
4. Probe functionality check.....	12
5. Lift-off rotation .....	14
6. Automatic detection .....	16
7. Scan zone definition.....	19
8. Acquisition .....	23
8a. Single pass .....	23
8b. Raster scan.....	24
8c. Spyne keypad.....	27
8d. Limitations.....	27
9. Analysis and reporting .....	29
9a. Indications display.....	29
9b. Indications merging criteria .....	30
9c. Building the report.....	31
9d. Generating the report.....	32
10. High-pass median filters.....	33
11. Detection of hard spots.....	34
12. Encoder calibration.....	36

## 1. Probe Description

### 1a. Spyne scanner

Bending curvature: 150 mm (6 in.) OD to flat

Maximum temperature of operation: 150 °C (300 °F)

Maximum probe speed: 600 mm/s (24 in/s)

Mechanical features:

1. Detachable, high-precision encoder (25.87 count/mm)
2. Holder slots for grid-as-you-go markers
3. Silicone wheels, easily swappable with magnetic wheels
4. Detachable handles
5. Central attachment to the Spyne eddy current array (ECA) probe
6. Detachable keypad
7. Scan direction
8. Temperature-resistant PET cable sleeve



Figure 1. Spyne scanner features

## 1b. Spyne scanner accessories

Holders for grid-as-you-go markers, compatible with regular ink Sharpie, or solid paint markers for high temperature surfaces such as Markal's *Quik Stick Mini*



Pointer attached to the front of the probe, to help following the grid-as-you-go marking lines

Aluminum tool for functionality check and calibration check (see section 4 of this user guide)



Fischer to Amphenol cable adapter (ADAPT-ENC-12X18) that allows using the Spyne scanner with an Ectane

Ten replacement PEEK layers (thickness 0.25 mm, 0.010 in.) for the protection of the Spyne probes. Always make sure to replace the PEEK layer on the probe before the PCB itself gets damaged. More layers can be purchased directly from Eddyfi.



Set of 16 magnetic wheels for the inspection of ferromagnetic surfaces, available as an option with the Spyne scanner. Easily swappable with the standard silicone wheels.

## 1c. Spyne probes

Probe characteristics:

ECA-SPYNE...	-C-202-250-086	-C-203-250-066	-D-200-250-066
<i>Material to inspect</i>	Ferromagnetic	Ferromagnetic, Non-ferromagnetic (subsurface defects)	Non-ferromagnetic (surface defects)
<i>Topology</i>	Long, single driver	Long, single driver	Short, double driver
<i>Coverage</i>	202 mm (8.0 in.)	203 mm (8.0 in.)	200 mm (7.9 in.)
<i>Coil size</i>	4.5 mm	6.0 mm	6.0 mm
<i>Number of coils</i>	86	66	66
<i>Number of channels</i>	126	127	128
<i>Defect orientation</i>	All orientations (cracks, pittings, etc.)		
<i>Max T° of operation</i>	150 °C (300 °F)		

Probe features:

1. High-density connectors to the Spyne scanner
2. Central attachment point to the Spyne scanner
3. Memory Integrated Circuit (memory IC) for calibration data storage
4. PEEK tape for wear protection, thickness 0.25 mm (0.010 in.)

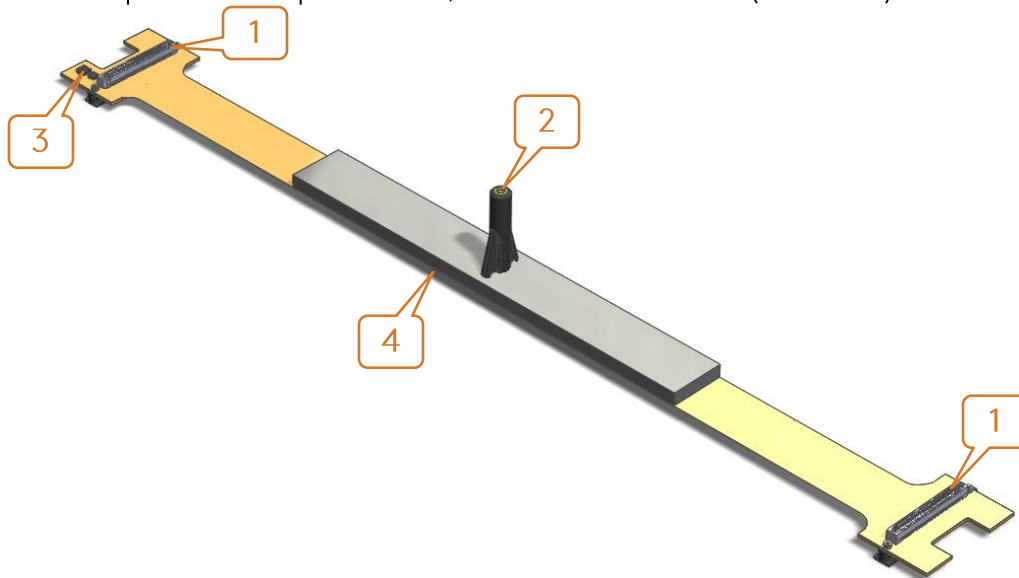
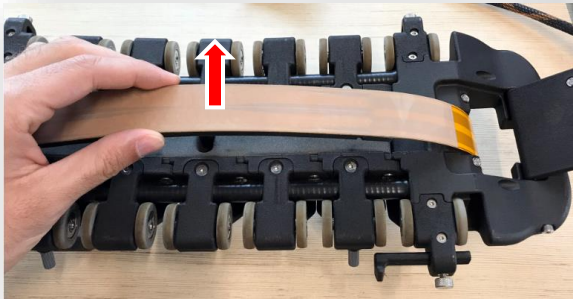

Figure 2. Spyne probe features

## 1d. Spyne probe replacement

One advantage of the Spyne is the possibility to use different probes with the same scanner. For example, a single Spyne scanner can be used to inspect both ferromagnetic and non-ferromagnetic materials simply by swapping the probes, which takes less than a minute:

I) Unscrew the encoder, the keypad and the central attachment point, and disconnect the connectors at both ends.



II) Turn the Spyne upside down, open the side doors and remove the probe.

III) Insert the new probe by placing the side with the memory IC on the same side as the scanner cable, and close the side doors.

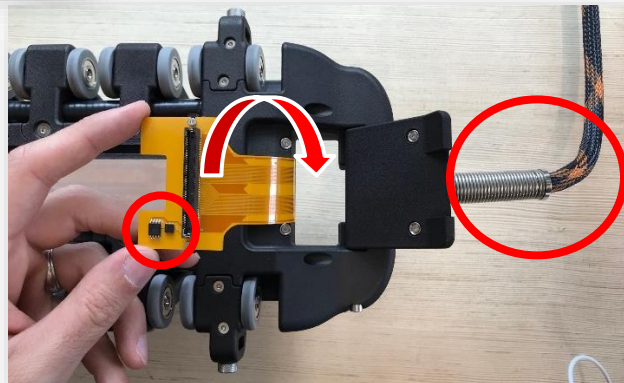

IV) Reconnect both probe connectors and screw the central attachment point, the keypad and the encoder back on.

## 2. Magnifi setup

---

### 2a. Preparing the setup

The terms *backstage* and *frontstage* used in this guide refer to the two main windows of Magnifi. To switch between the backstage and frontstage, click on the triangle icon at the top left of the screen: . The backstage is displayed at the opening of Magnifi and contains the options related to the inspection, data management and general preferences. The frontstage is the main window for acquisition and analysis.

There are two ways to prepare a setup for a Spyne inspection:

- I) A customized setup can be generated using the dedicated Spyne setup wizard, which will guide the user through all the adjustable parameters in order to adapt it to the inspection specifications.

This setup is generated from the frontstage, by clicking on *New* → *Spyne Setup* from the *Setup* tab in the top ribbon. A description of all the adjustable setup parameters is provided in section 2b.

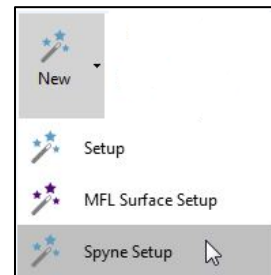

- II) A generic Spyne setup with default scan parameters can be loaded from the default setup list of Magnifi located in the backstage, by selecting *Open Setup*  → *Default Master List* → *Spyne*, and by selecting the corresponding probe.

Once this default setup has been loaded, all the scan parameters can still be modified manually from the *Setup* tab (see section 2b).

All Spyne probes purchased after the release of Magnifi 4.7 in April 2020 have been pre-calibrated to ensure a uniform response of all their channels, without the need to bring a large calibration plate to each inspection site. This pre-uniformization is embedded in the probes and cannot be disabled. It is also specific to each probe and thus unrelated to the setup being used. In other words, swapping the Spyne probe in the middle of an inspection will have no effect on data collection: the instrument will always apply a pre-uniformization that is specific to the probe currently connected.

In versions of Magnifi prior to 4.7, or for probes purchased before April 2020, the pre-uniformization will not be recognized. Instead, a USB key with a pre-uniformized setup file was included with the probe.

More information on the pre-calibration process can be found in the datasheet provided with the probe.

## 2b. Setup parameters

The Spyne setup wizard will guide the user through 6 steps, which can also be accessed individually from the *Setup* tab:



Probe selection: Selection of the Spyne probe being used. The probe reference name is indicated beside the probe connector, under the scanner's keypad.



Scan definition: Configuration of the scan parameters:

- Scan type (single pass or raster)
- Acquisition type (clock-based or encoder-based)
- Probe speed, acquisition density and acquisition frequency
- Geometry of the scanned area (see section 7)

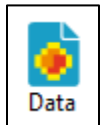

Data definition: Fine-tuning of the hardware electrical parameters (injected current's frequency, amplitude and phase, hardware gain).

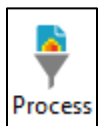

Data processing: Adjustment of the C-scan filters:

- Low-pass filter: used to remove high-frequency signals caused by a poor surface condition, vibrations, electronic noise, etc. A longer window size will provide a more aggressive filter.
- High-pass median filter: used to remove low-frequency signals caused by large areas of corrosion, lift-off, changes of magnetic permeability, etc. A shorter window size will provide a more aggressive filter. See section 10 for more details on how to use the high-pass median filter.



Indication codes: Managing the different types of indication codes used for the indications that are added manually to the report.



Display: Configuration of the display options during and after acquisition.



## 2c. Setup layout

1. Axial C-Scan: Visualization of axial indications of crack colonies. In the example below, 3 axial crack colonies were automatically detected and localized with yellow boxes in the C-scan. Horizontal white lines spaced by 25.4 mm (1 in) will help locate these defects on the inspected surface. To display a C-scan without these lines, switch to the alternative layout display, under the *Select* menu of the *Layout* tab.
2. Axial Lissajous: Impedance plane for the data points within the axial C-scan cursor. In the example below, the red horizontal line represents the signal threshold for automatic detection. Because the signal of the indication inside the cursor gets above this line, an indication box is automatically added in the axial C-scan.
3. Transverse C-Scan: Visualization of transverse (circumferential) indications of crack colonies. In the example below, no transverse crack was detected.
4. Transverse Lissajous: Impedance plane for the data points within the transverse C-scan cursor. Since the signal of the indication inside the cursor doesn't get above this line, no indication box is added in the transverse C-scan.



Figure 3. Spynce setup layout for acquisition and analysis

To change the settings of any of these windows, first select it to highlight its outline in orange, and go to the *Current View* tab. To switch a C-scan view between axial and transverse data, click on the *A* or *T* in the top left corner of the window.

By default, the axial indications will only appear in the axial C-scan, and the transverse indications will only appear in the transverse C-scan. To display the indications in all C-scans, check the corresponding option in the *Analysis* section of the *Preferences* menu.

### 3. Data management

This section suggests a convenient way to manage and save automatically large numbers of data files during an inspection. The following steps can be done in advance in Magnifi, before getting to the inspection site.



- I) In the backstage of Magnifi, in the *Inspection* menu, select a project folder and an inspection folder .
- II) In the *Acquisition* menu, select the *Prefix* filename option.
- III) Click *Create New List*.
- IV) Select the prefix for the files name, the number of elements (i.e. data files) in the list, the index for the first data file and the index increment between each file. The example below shows an example of list based on the following parameters:

Selected parameters:



Prefix:	SCC
Number of elements:	4
Element start number:	10
Element increment:	2

Resulting list of data files:

Prefix	Index
SCC	010
SCC	012
SCC	014
SCC	016





- V) Click *Create*.
- VI) Switch to the frontstage by clicking on the triangle  in the top left corner of the screen. If you are starting a new inspection, the *acquisition summary* window will immediately pop up and prompt you to enter the information relative to the current inspection (component type, client, service provider, etc.). This information can be modified later through the *Acquisition summary* tab in the backstage.
- VII) In the frontstage, in the *Layout* tab, make sure the *Data*  button is checked. The list of data files will be displayed on the left side of the screen.
- VIII) At the bottom of the list of data files, click *Acquisition preferences* , and make sure the following two options are checked:
  - i) *Automatic file recording*
  - ii) *Automatic Next on Stop Acquisition*

When an acquisition is stopped, these two options will allow to save automatically the data file and select the next one in the list. The next acquisition can then be started immediately, without any other action required.





- IX) If an Ectane is being used, connect to the instrument by clicking *Connect*  in the Instrument tab.
- X) Once the setup parameters and preferences are settled, uncheck *Setup Mode*  in the *Home* menu. Otherwise, in setup mode, no data will be saved automatically.
- XI) In the list of data files, select the first file to be acquired. The inspection can begin.

A few more information about data management in Magnifi:

- o The small icon beside each data file indicates its current state:

Icon	Definition
	The data file has not been acquired yet (empty file)
	The data file was acquired and saved, but has not been analyzed yet
	The data file was acquired, saved and analyzed, and it was reported as being free of indications
	The data file was acquired, saved and analyzed, and indications have been reported
	The data file is tagged for further review

For more information on data analysis, refer to section 9 of this user guide.

- o At any time during the inspection, the user can click *Add data*  or *Delete data*  at the bottom of the list of data files. Data files added with this button will keep the same prefix, and their index will be incremented by the number selected in the index menu . To create data files with a new prefix, go back to the backstage and click on *Create New List*.
- o To re-scan a data file that has already been acquired and saved, select the data file and click *Re-scan* . To choose whether the original data file should be kept or erased, select the corresponding option in *Acquisition preferences* .

## 4. Probe functionality check

At the beginning and end of an inspection, it is good practice to verify that every channel of the probe is operating properly, to make sure that the inspection results are valid. The aluminum tool provided with the Spyne can be used for this purpose.

To proceed to the probe functionality check:

- I) Once the probe setup is loaded in Magnifi, click on *Cal. Check* in the *Calibration* tab. The *Calibration Check* window will open, and some scan parameters (filters and encoder-based acquisition) will be disabled temporarily to perform the check.
- II) Set the Spyne flat, upside down on a stable surface, with the probe facing up.
- III) Null the probe in this position, and start an acquisition.
- IV) Place the nose of the aluminum tool in the long groove, at one end of the scanner, as displayed in Figure 4. Slide the tool along the length of the ECA probe by applying pressure on it, to make sure that its nose stays at the bottom of the groove the whole time. The eddy current sensors will react to the presence of the aluminum and will produce a characteristic signal in the C-scans.

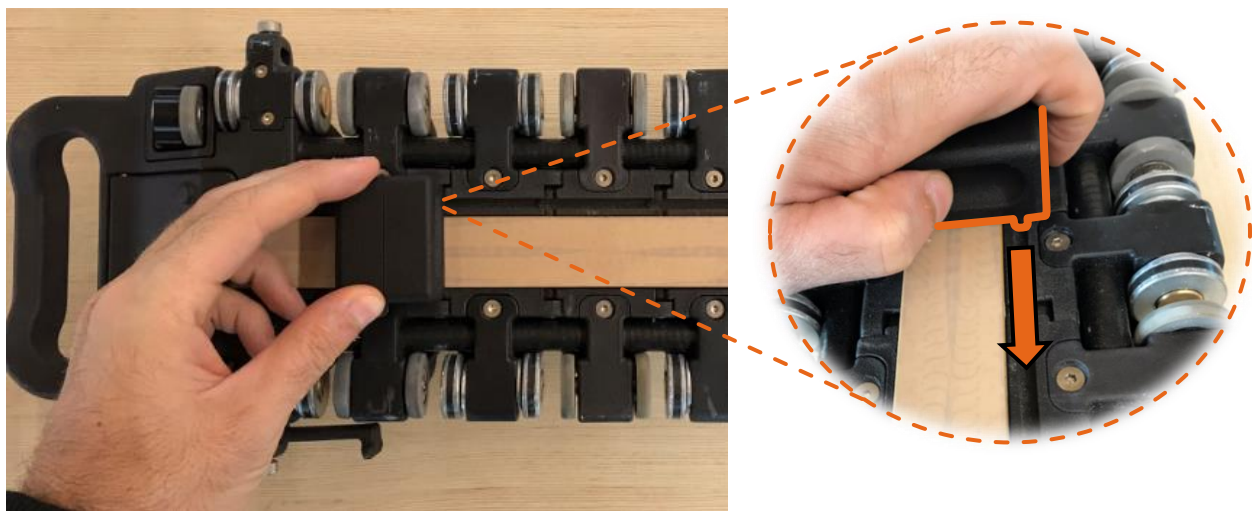

**Figure 4.** Probe functionality check with the nose of the aluminum tool inside the long groove. The aluminum tool is sliding along the entire length of the ECA probe, causing a signal response from each of the probe's sensor.

- V) Stop the acquisition. Both the axial and transverse C-scans should display a diagonal signal similar to Figure 5. The orientation of the diagonal line does not matter: it depends on the direction of the aluminum tool during the acquisition.
- VI) Check both the *F1A* and *F1T* boxes, and click *Check*. Two green check marks will show that all axial and transverse channels have acquired a signal from the aluminum tool, and that no sensor is damaged.



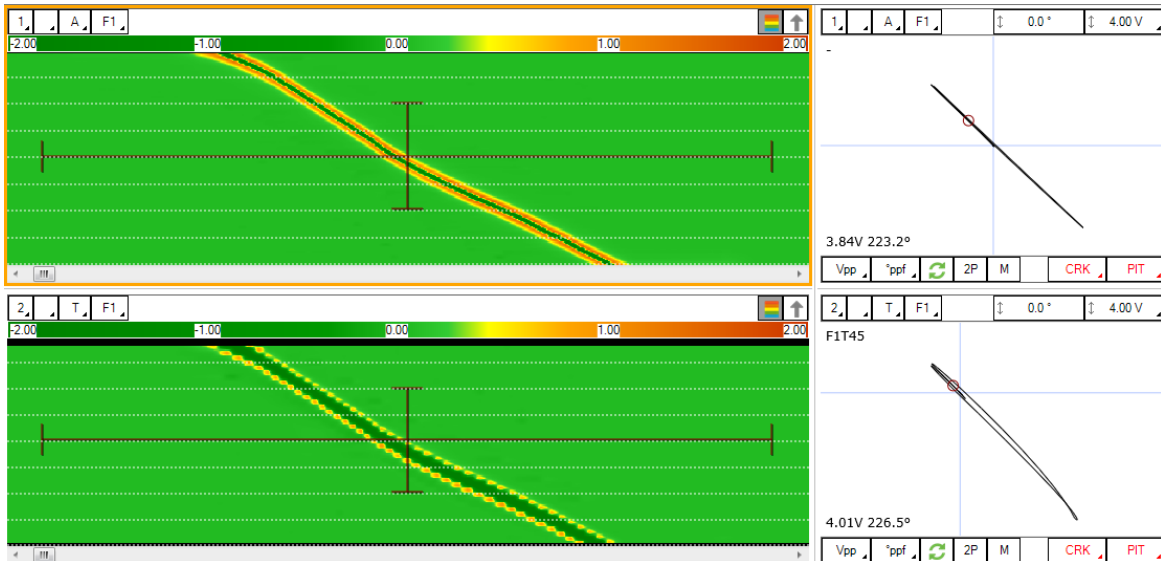



Figure 5. Example of diagonal-shaped signal obtained from the probe functionality check.

- VII) This data cannot be saved, but a screen capture can be saved with *Capture* . This will create a .png file named *CalCheck* in the current inspection folder.
- VIII) After completing these steps, the *Calibration Check* window can be closed, which will reenables the filters and encoder-based acquisition.

Instead of using the aluminum tool, a calibration sample with a long EDM defect can be used to validate the uniformity of the probe: this is a *calibration check*. In this case, stricter settings can be applied to ensure that the signal amplitude and phase of all channels lie within a certain tolerance that is conform with the inspection procedure (for example, all channels within  $5.0 \pm 0.5$  V and  $60 \pm 5$  °). This can be adjusted in the *Edit Settings* menu of the *Calibration Check* window.

If necessary, the global amplitude and phase of the signal can also be tuned:

- o To modify the amplitude of the signal, modify the gain in the *Data*  menu of the Setup tab. This will apply a uniform gain to all channels of the probe.
- o To modify the phase of the signal, rotate the signal by dragging the rotation button up or down in the Lissajous window. This will apply a uniform rotation to all channels of the corresponding C-scan.

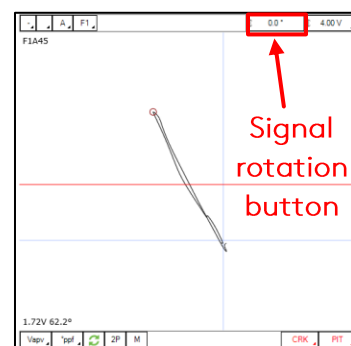

Note that if the probe functionality check (or calibration check) is done after modifying the global amplitude, phase or eddy current frequency, the tolerance settings may need to be modified as explained above, in order to be kept consistent with the new setup parameters.

## 5. Lift-off rotation

---

The following steps should be performed on the component under examination before beginning the inspection, to ensure that the phase of the eddy current signal is adjusted properly. This will help decreasing the inspection noise caused by lift-off and surface imperfections (i.e. corrosion, paint, dirt...) and will ensure that the defects have an orientation that will optimize their probability of detection.

- I) Click on *Lift-off Assist.* in the *Calibration* tab. The *Lift-off Assistant* window will open, and some scan parameters (filters and encoder-based acquisition) will be disabled temporarily to perform the lift-off adjustment. This will also modify the Lissajous windows temporarily to display the impedance signal of multiple channels simultaneously.
- II) Put the Spyne on a clean section of the surface under examination. For optimal results, the surface should be as clean as possible (free of cracks, corrosion...) and representative of the rest of the surface being inspected. For example, if the entire surface is coated, the Spyne should be placed on a coating of the same thickness.
- III) With the entire length of the Spyne in good contact with the surface, null the probe (default keyboard shortcut: F6).
- IV) Start an acquisition (default keyboard shortcut: F2).
- V) Slowly lift the probe in the air, and stop the acquisition. If magnetic wheels are used, start by lifting both extremities of the scanner before lifting the entire body.



Figure 6. Spyne lift-off calibration: 1) Null the Spyne on a clean section of the inspected surface, with the whole length of the probe in good contact with the surface; 2) Start an acquisition and slowly lift the probe in the air.

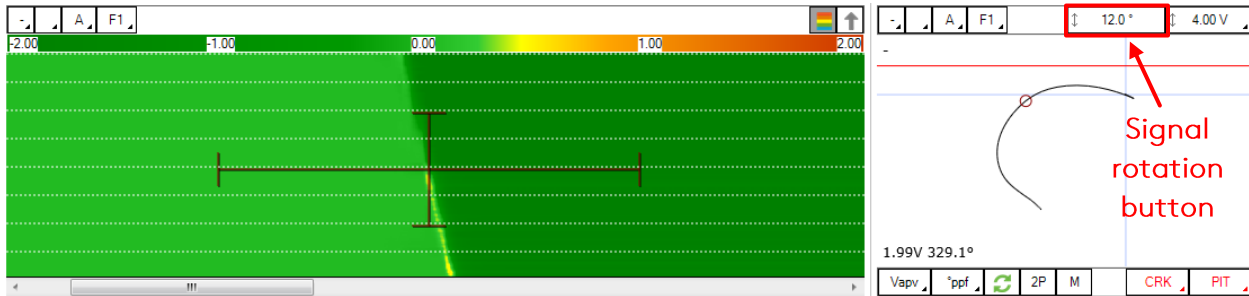

Figure 7. Positioning of the C-scan cursor at the transition between the material and the air.

VI) Figure 7 above shows an example of axial C-scan and Lissajous obtained from the lift-off. Rotate the lift-off signal in order to have the beginning of the impedance curve pointing toward the left, around  $0^\circ$ , for each channel displayed. Depending on the amount of lift-off variation expected during the inspection (due to the level of corrosion, the uneven thickness of the coating, etc.), the curve can be rotated with its beginning pointing slightly upward, allowing the defect indications to have a higher phase at high lift-off values. See the example in Figure 8 below.

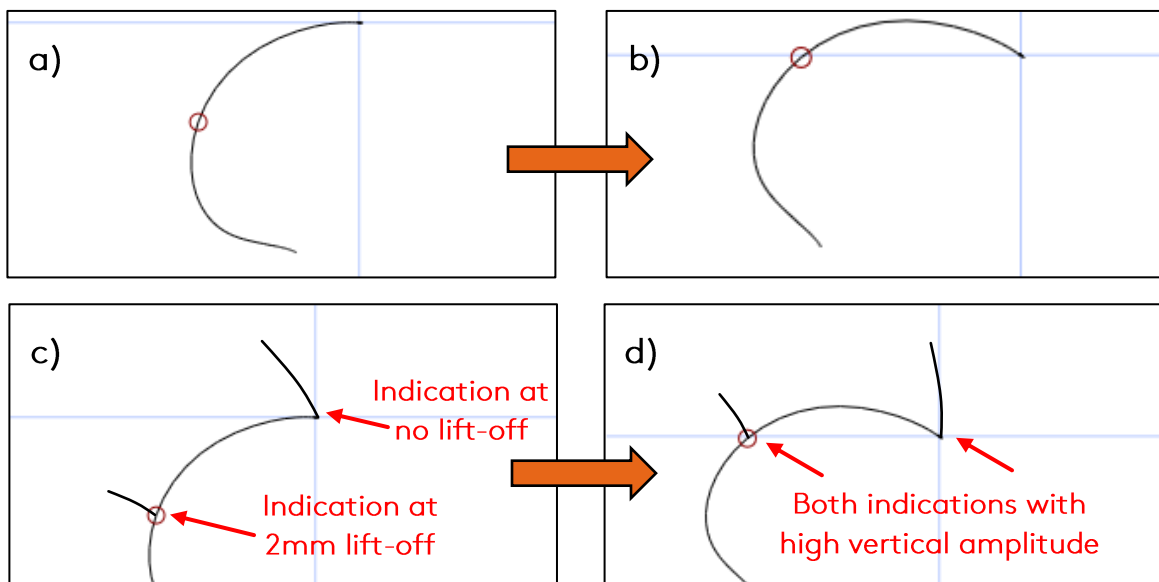

Figure 8. a) Typical lift-off signal orientation, with the beginning of the curve pointing strictly to the left; b) Rotation allowing the beginning of the lift-off curve to be oriented slightly upward; c-d) Typical signal of a crack indication in carbon steel for orientations a) and b) respectively, showing that orientation b) leads to a higher signal phase (higher vertical amplitude) that increases the probability of detection of defects at higher lift-off.

VII) This data cannot be saved, but a screen capture can be saved with *Capture* . This will create a .png file named *LiftOff* in the current inspection folder.

VIII) After completing these steps, the *Lift-off Assistant* window can be closed, which will reenables the filters and encoder-based acquisition.

## 6. Automatic detection

---

The Spyne is a high-resolution detection tool that can detect millimeter-sized cracks in a large variety of materials. Depending on the application, this can lead to hundreds of indications detected during a single scan.

To facilitate the efficient reporting of large numbers of indications, a lot of efforts have been put into Magnifi toward the automatic detection of defects. By default, this automatic detection is based on a vertical signal threshold: indications with a vertical signal amplitude higher than the threshold will be automatically marked in the C-scan.

The user should keep in mind that the signal amplitude is not affected only by the depth of the defects. The length, width, orientation and density of the defects will all affect the signal. For this reason, the Spyne cannot be used for depth measurement.

In the default Spyne setup, the signal threshold is set to 0.50 V. For the probes operating in single driver (for ferromagnetic materials), this corresponds to the signal of an isolated 3 mm X 1 mm (0.120" X 0.040") crack. For the probes operating in double driver (for non-ferromagnetic materials), it corresponds to an isolated 2 mm X 1 mm (0.080" X 0.040") crack. Note that these numbers are approximate and will highly depend on the material type, its magnetic permeability, the geometry of the surface, the level of corrosion, and the amount of lift-off. For this reason, the signal threshold should be fine-tuned with a representative calibration sample containing the smallest defect that needs to be detected.

To adjust the alarm threshold by using a calibration sample with a target defect:

- I) Perform a lift-off rotation as described in section 5.
- II) Null the probe on a clean section of the calibration sample.
- III) Start an acquisition and scan the target defect.
- IV) Move the C-scan cursor on the target defect in the C-scan corresponding to the orientation of the defect (axial or transverse). Locate the channel displaying the highest vertical amplitude by using the up and down arrows while keeping an eye on the corresponding Lissajous window.
- V) Use either of the following methods to adjust the signal threshold to the desired level of sensitivity:
  - a. Select the corresponding Lissajous window (axial or transverse), and enable the *Edit Alarm*  button in the *Current View* tab. Drag the red horizontal line in the Lissajous to approximately 75% of the maximum amplitude.
  - b. With the amplitude measurement set to *Absolute Peak Vertical* ("Vapv" at the bottom left corner of the Lissajous window), note the signal amplitude of the



target defect. Open the *Detect Indication* window (located in the *Setup* tab on Reddy, and in the *Advanced* tab on Ectane, see Figure 10) and adjust the corresponding threshold (axial or transverse) at 75% of the measured value.

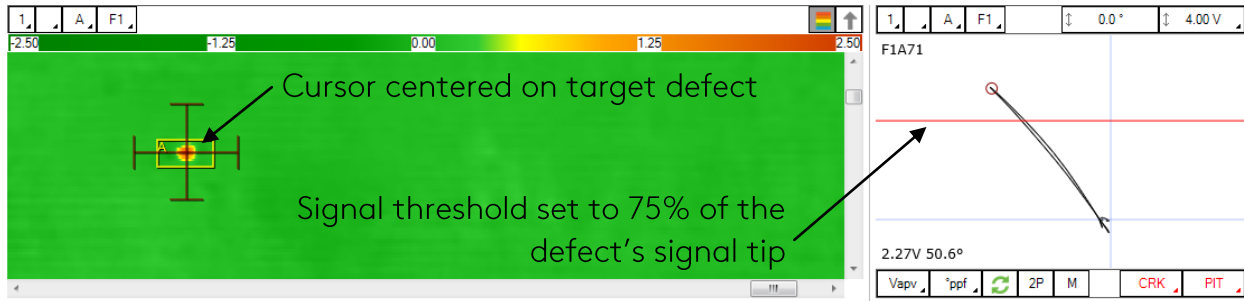

Figure 9. Example of a proper adjustment of the automatic detection signal threshold, using a calibration sample with a single axial defect.

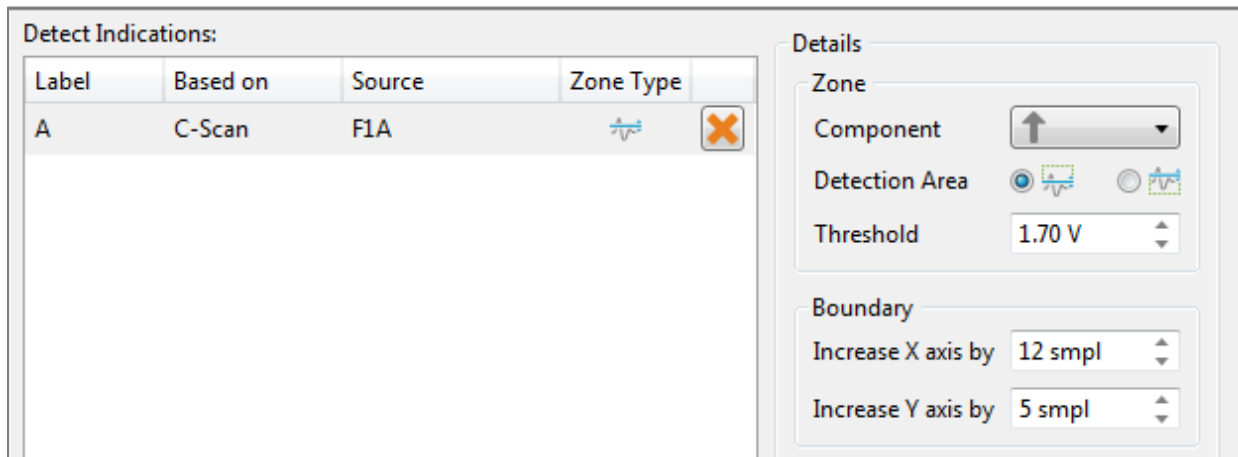

Figure 10. The *Detect Indications* window offers the following options; *Label*: indication name displayed in the C-scans and in the report; *Based on*: for Spyne and ECA in general, the detection is always based on the C-scans; *Source*: name of the C-scan associated to the detection (by default, F1A for axial indications and F1T for transverse indications); *Zone type* and *Zone details*: conditions for automatic detection – by default, a simple vertical threshold is used, but rectangles and quadrants are also available, as presented in the example next page; *Boundary*: distance criteria for merging nearby indications – refer to section 9b for more details on this merging behavior.

- VI) Re-scan the target defect multiple times to ensure that it is always detected automatically. A yellow box will appear around the indication in the C-scan.
- VII) If necessary, repeat steps II through VI for the second C-scan (axial or transverse) by scanning the same defect with a 90° angle shift.

For surfaces with major sharp-edged corrosion, a simple signal threshold like the one presented above may not be sufficient to discriminate corrosion edges from actual cracks having the same orientation. The example below shows how replacing this threshold by a quadrant zone can help to separate the two types of indications.

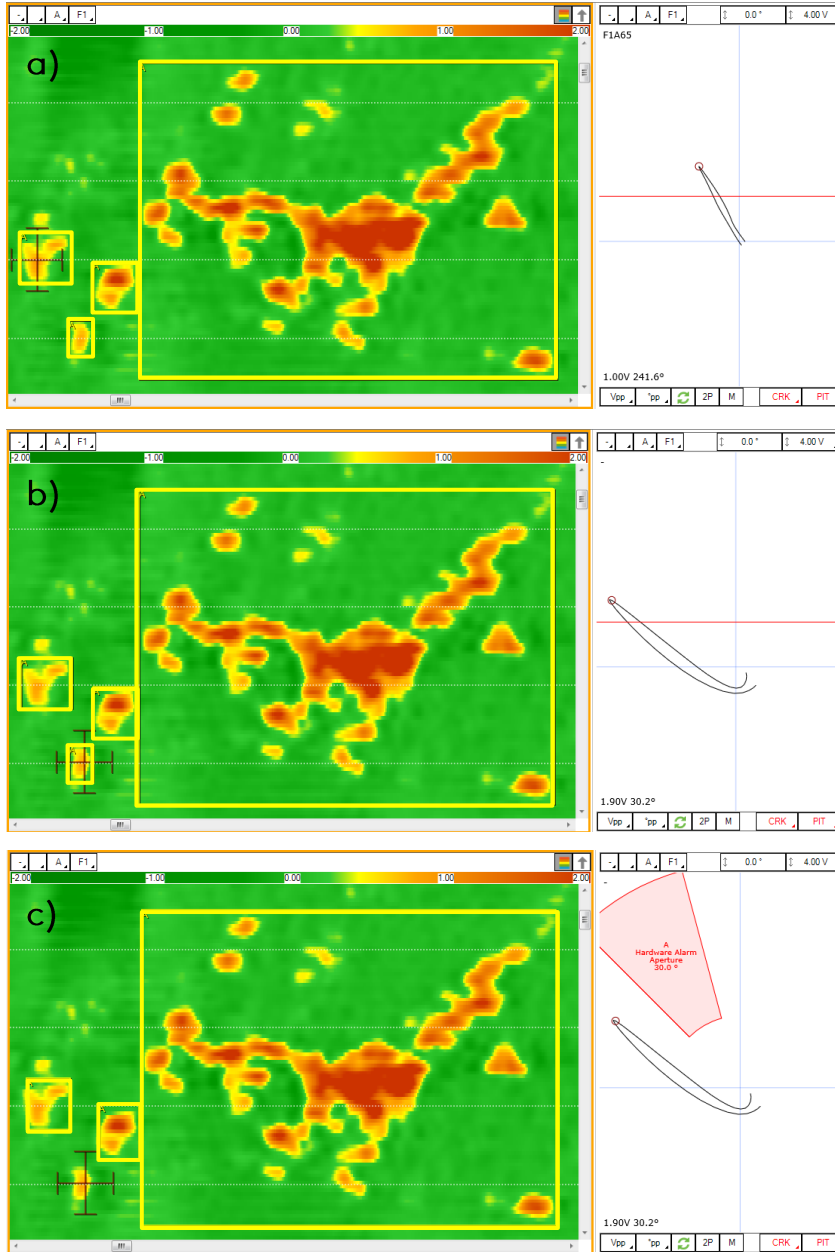



Figure 11. a) The left-most C-scan indication exhibits the typical impedance signature of a crack, with its orientation at 60°. Since it crosses the signal threshold, it is correctly marked as an axial crack indication in the C-scan; b) The second left-most indication has a different impedance signature, with a hook shape and a 30° orientation. This is typically associated with sharp-edged corrosion. Because this indication also crosses the signal threshold, it is incorrectly marked as an axial crack in the C-scan; c) The signal threshold has been replaced by a quadrant centered at 60° and with an aperture of 30°. This allows the discrimination of the indications based on their phase: as shown in the C-scan, the corrosion is now dismissed and only the actual crack indications are marked as axial defects.

The signal threshold can be replaced by a quadrant by changing the *Zone Type* in the *Detect Indications* menu. The orientation, aperture, inner radius and outer radius can all be adjusted from this menu or manually in the Lissajous.

Label	Based on	Source	Zone Type
A	C-Scan	FIA	 

## 7. Scan zone definition

Regardless of the surface being inspected, a scan zone should always be defined before starting an acquisition, to facilitate the tracking of the defects location and to ensure that the entire surface will be inspected without any remaining unscanned area. This section of the user guide presents an example of recommended reference scan zone.

The scan zone is defined by the following two parameters:

### 1) The datum reference:

The first parameter to define is the circumferential and axial origin of the scan zone. For the specific case of a pipe:

- o The circumferential origin is typically set on top of the pipe, at 0° (12 o'clock). A chalk line or measuring tape can be used to draw the 0° line along the whole length of the pipe. During the first scan, the pointer in front of the Spyne should be aligned with this line (Figure 12).
- o For pipes, the scan direction is typically oriented with the flow. To set the axial origin, the Spyne should first be placed on the pipe at the start position of the scan. To ensure that each scan will start at this exact axial position, a full circumferential line should be drawn aligned with the front of the Spyne.

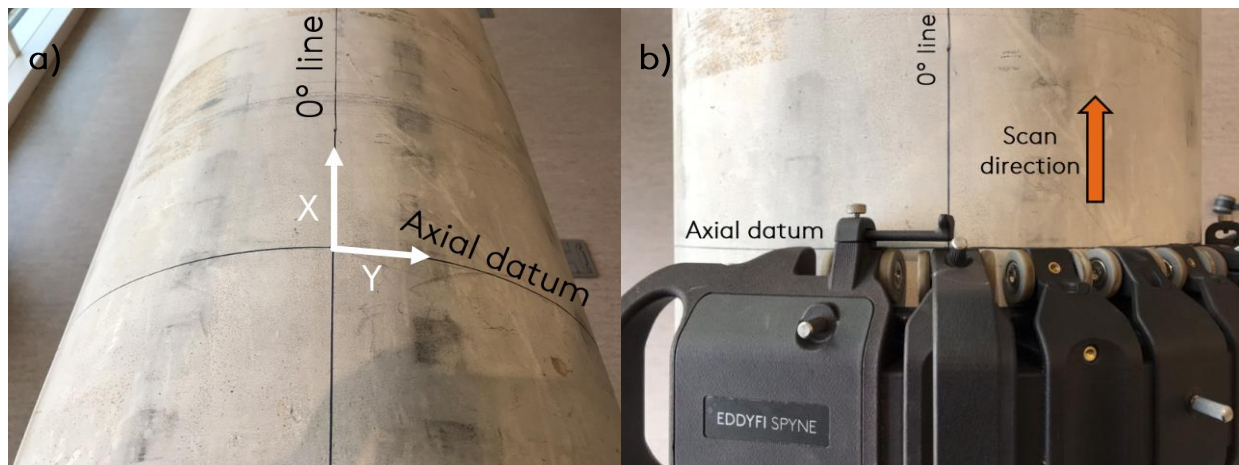
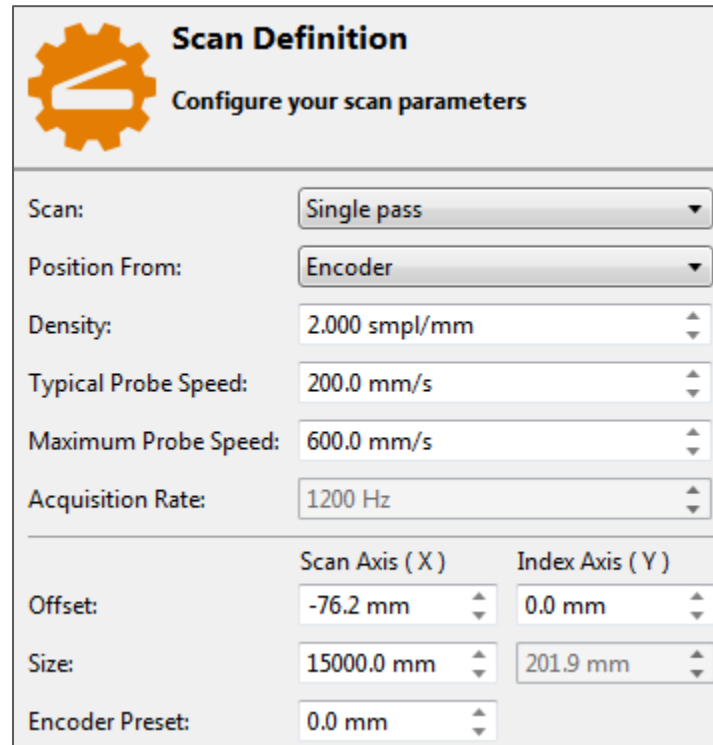

Figure 12. a) The X and Y datum lines should be defined and marked prior to beginning an inspection; b) Recommended position of the Spyne at the start of a pipe inspection: the front of the Spyne is aligned with the axial datum line, and the pointer is aligned with the 0° line.

Based on the chosen reference datum lines, a series of parameters can be adjusted in *Setup* → *Scan*. The default parameters are the following:



Scan Definition		
Configure your scan parameters		
Scan:	Single pass	
Position From:	Encoder	
Density:	2.000 smpl/mm	
Typical Probe Speed:	200.0 mm/s	
Maximum Probe Speed:	600.0 mm/s	
Acquisition Rate:	1200 Hz	
	Scan Axis ( X )	Index Axis ( Y )
Offset:	-76.2 mm	0.0 mm
Size:	15000.0 mm	201.9 mm
Encoder Preset:	0.0 mm	

Figure 13. Default scan parameters for the probe ECA-SPYNE-C-202-250-086.

- The *Scan* menu allows switching between single pass scans and raster scans (see section 8 for more details on these two acquisition modes).
- *Position From* allows switching between clock- and encoder-based acquisition.
- *Density* corresponds to the axial resolution (the number of data points acquired per unit of axial distance).
- *Typical* and *Maximum Probe Speed* are based on the user's preferences.
- The *Encoder Preset* at the bottom of the screen represents the position of the axial datum line relative to what is considered to be the X = 0 position. For pipelines, the X = 0 reference usually corresponds to the upstream girth weld. For tank walls inspected vertically, the X = 0 could be either the floor or ceiling, depending on the scan direction.
- The *Offset* refers to the axial (X) and circumferential (Y) start position of the C-scan. Since the Spyne sensors are located approximately 75 mm (3 in) behind the front of the scanner, data is always being recorded 75 mm before the datum reference. If this additional data is of no interest to the user, the *Offset* should be set equal to the *Encoder Preset* to avoid displaying it in the C-

scan. Otherwise, if the operator is interested to find potential crack indications immediately behind the datum line, the Offset should be set 75 mm (3 in) before the *Encoder Preset*, as it is set by default.

- o The *Size* corresponds to the axial (X) and circumferential (Y, only adjustable for raster scans) length of the C-scan. It should take into account the actual scan length and the selected Offset. It is good practice to use a *Size* value slightly longer than strictly necessary, to avoid missing data in case the scan length ends up being slightly longer than planned.

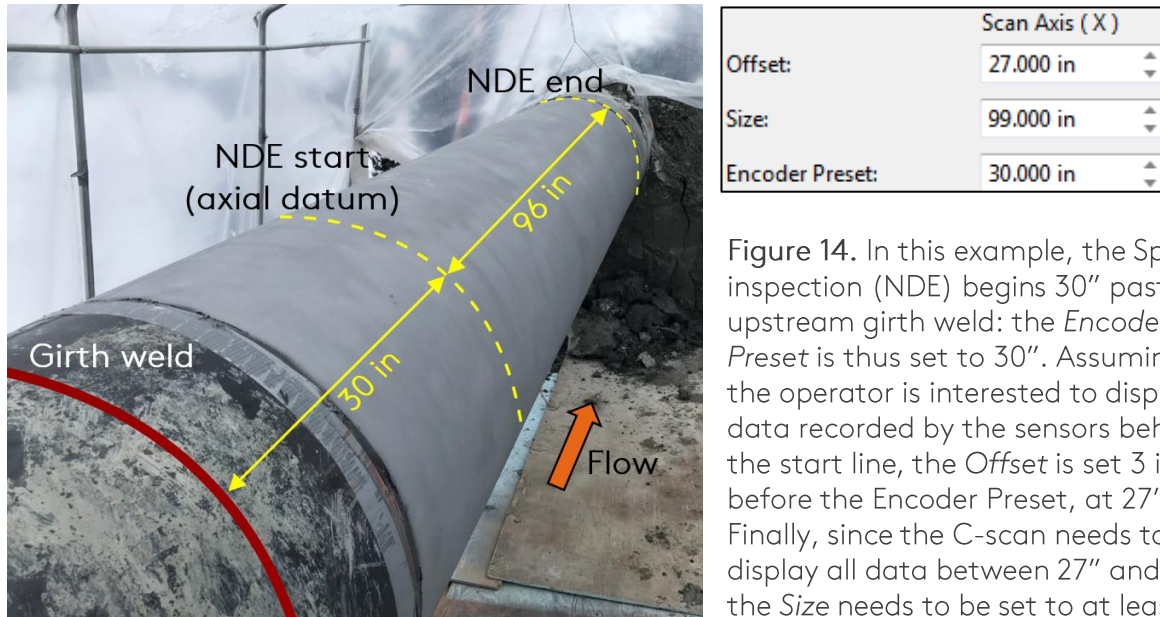

Figure 14. In this example, the Spyne inspection (NDE) begins 30" past the upstream girth weld: the *Encoder Preset* is thus set to 30". Assuming that the operator is interested to display the data recorded by the sensors behind the start line, the *Offset* is set 3 inches before the *Encoder Preset*, at 27". Finally, since the C-scan needs to display all data between 27" and 126", the *Size* needs to be set to at least 99".

## II) The overlap width:

The second important parameter to define is the circumferential overlap width between each scan. It is good practice to use an overlap of at least 10 mm (~ ½ in) to avoid missing defects between two passes. Without any overlap, every slight lateral movement of the Spyne during the scan will cause a dead zone in which defects could be missed.

The overlap width is set relatively to the coverage indicators on the sides of the probe (Figure 15a). The pointer should be aligned with the beginning of the probe coverage, and the marker holder should be adjusted to the desired overlap width (Figure 15b-c). Note that the overlap width will vary with the curvature of the Spyne. For this reason, the pointer and marker holders should be adjusted only after setting the Spyne to the correct curvature. Note that instead of using markers to draw the lines during the scan, chalk lines can be made before beginning the inspection to ensure a proper overlap.

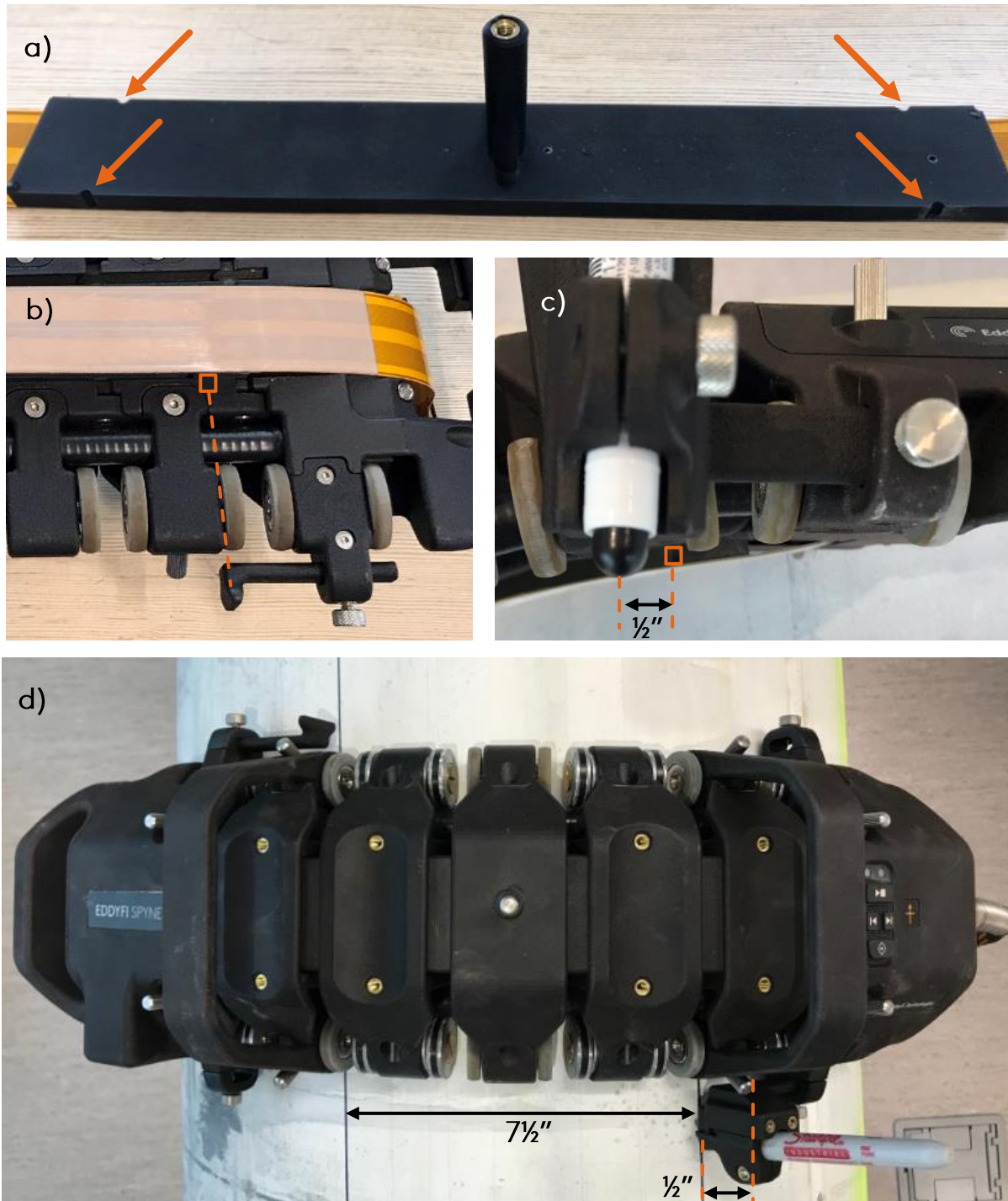

Figure 15. a) Four indicators of coverage on the Spyne probes; b) Pointer attached to the front of the probe and aligned with the beginning of the coverage; c) Marker overlap, adjusted at the rear of the probe; d) Example of acquisition with an  $\frac{1}{2}$ " overlap, showing that the width of each pass is equal to the probe coverage (8 in) minus the overlap.

## 8. Acquisition

### 8a. Single pass

By default, the Spyne setup is set to single pass acquisition. In this mode, each axial scan will be recorded as a separate data file. The only relevant parameter is the scan length (X-axis), which can be modified in *Setup* → *Scan*. With the default resolution of 2 samples/mm (50 samples/inch), the maximum scan length for a single data file is approximately **50 meters (2000 inches)**.

If the entire inspection requires more than one pass (more than one data file), markers or chalk lines should be used to control the overlap between each pass, as explained in the previous section. The pointer in front of the Spyne should also be used to follow the line, to ensure a straight axial movement. For a clockwise inspection (2<sup>nd</sup> pass to the right of the 1<sup>st</sup> pass), the marker should be installed on the right side of the Spyne and the pointer on the left side, as depicted in Figure 16 below:



Figure 16. Clockwise scans with the pointer on the left side and the marker on the right side. The pointer follows the 0° line during the first pass, and follows the lines drawn by the marker during the subsequent passes.

To perform a single-pass acquisition:

- I) Null the probe  on a clean section of the component being inspected (as much as possible free of visible defects, corrosion, etc.)
- II) Place the Spyne on its start position (Figure 12)
- III) Start the acquisition and roll the Spyne axially along the surface to inspect
- IV) Stop the acquisition

All these actions can also be performed directly with the Spyne keypad (see section 8c).

If the maximum scan speed was exceeded during the inspection and data was missed, black vertical lines will be visible in the C-scan. Without stopping the acquisition, the Spyne can be rolled back to the area with missed data to remove the black lines.

Depending on the selected acquisition preferences (see section 3 VIII), the next data file can be selected automatically after stopping the acquisition, to facilitate the efficient acquisition and recording of multiple data files.

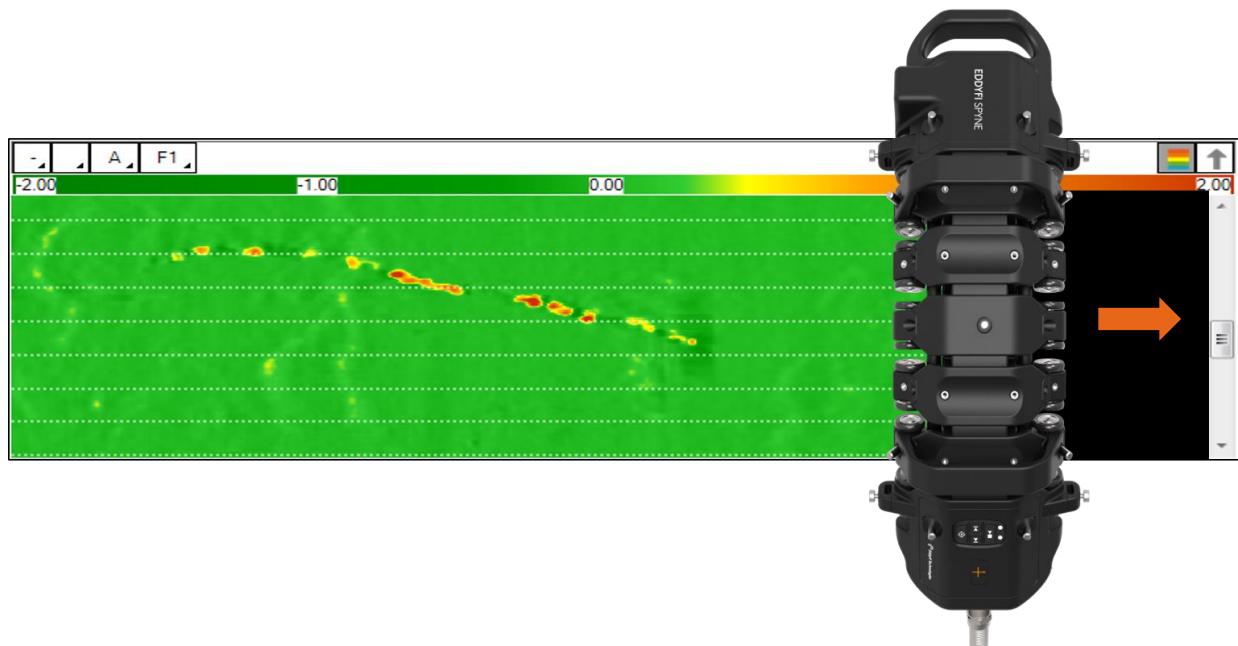

Figure 17. Example of a single-pass data file. The height of the C-scan corresponds to the probe coverage (200 mm or 8 in), with the bottom of the C-scan always corresponding to the cable side of the Spyne. Horizontal white lines displayed at every inch help to locate the defects on the surface being inspected.

## 8b. Raster scan



For disambiguation, the word *raster* used in this document refers to a unidirectional scan: once the Spyne has reached the end of its first pass, it needs to be taken off the inspected surface and brought back to the start line. In this sense, *raster scan* refers to a “comb scan”.

To switch between the single pass and raster acquisition modes, go to *Setup* → *Scan*. In raster mode, two parameters become relevant: the scan length in the X-axis, and the scan length in the Y-axis. To set the appropriate scan length in the Y-axis, keep in mind that the Spyne coverage is approximately 200 mm (8 in). Thus, a scan length of 1200 mm (48 in) in the Y-axis will yield a raster scan of 6 passes.



Note that with the Spyne, the raster scan needs to be done in a clockwise orientation (from left to right, Figure 16). As a result, in Magnifi, the first pass will always be displayed at the top of the C-scan.

To perform a raster-scan acquisition:

- I) Null the probe  on a clean section of the component being inspected (as much as possible free of visible defects, corrosion, etc.)
- II) Place the Spyne on its start position (Figure 12)
- III) Start the acquisition and roll the Spyne axially along the surface to inspect
- IV) Take the Spyne off the surface and place it at its start position for the next pass
- V) In the Home tab, click on *Next Pass* 
- VI) Repeat steps III, IV and V for every pass of the raster scan
- VII) Stop the acquisition

All these actions can also be performed directly with the Spyne keypad (see section 8c).

The *Previous Pass* button  can be used to re-acquire a previous pass.

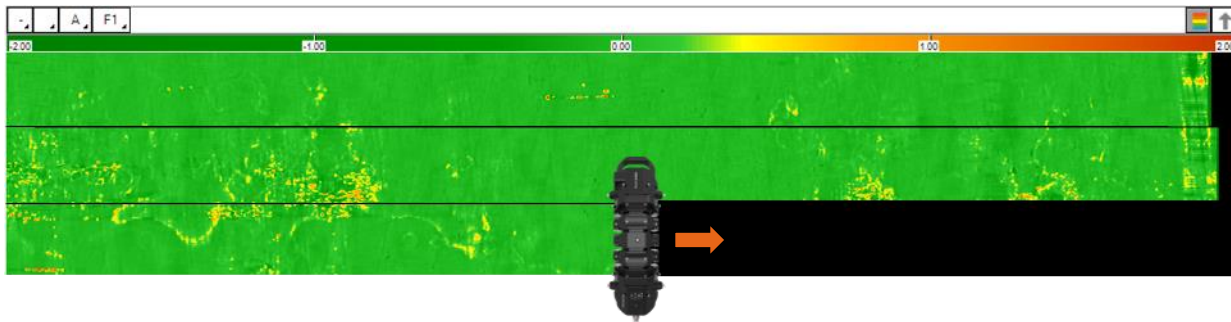

Figure 18. Example of raster-scan data file, which each pass displayed in a single C-scan.

When analyzing large raster scan data, it may be helpful to switch to a layout with a single C-scan instead of two. This can be done by clicking on *Layout* → *Select*. This will double the size of the windows and remove the horizontal white lines in the C-scan.

For the full 360° coverage of a pipe in a single raster scan, the table below helps to evaluate the maximum axial scan length allowed, based on the pipe diameter. The values are based on an overlap of 13 mm (½ in) between each pass.

Pipe outside diameter	Number of passes for full 360° coverage	Circumferential scan length (Y)	Maximum axial scan length (X) for full 360° coverage in a single raster scan
6"	3	600 mm (24 in)	17 m (670 in)
8"	4	800 mm (32 in)	12.5 m (500 in)
10"	5	1000 mm (40 in)	10 m (400 in)
12"	6	1200 mm (48 in)	8 m (320 in)
16"	7	1400 mm (56 in)	7 m (280 in)
20"	9	1800 mm (72 in)	5 m (200 in)
24"	11	2200 mm (88 in)	4 m (160 in)
30"	13	2600 mm (104 in)	2.5 m (100 in)
36"	16	3200 mm (128 in)	2 m (80 in)
42"	18	3600 mm (144 in)	1.5 m (60 in)
48"	21	4200 mm (168 in)	1 m (40 in)

To scan a larger surface than what is prescribed in the above table, multiple data files will be required. Figure 19 shows two options to divide a large surface into multiple files.

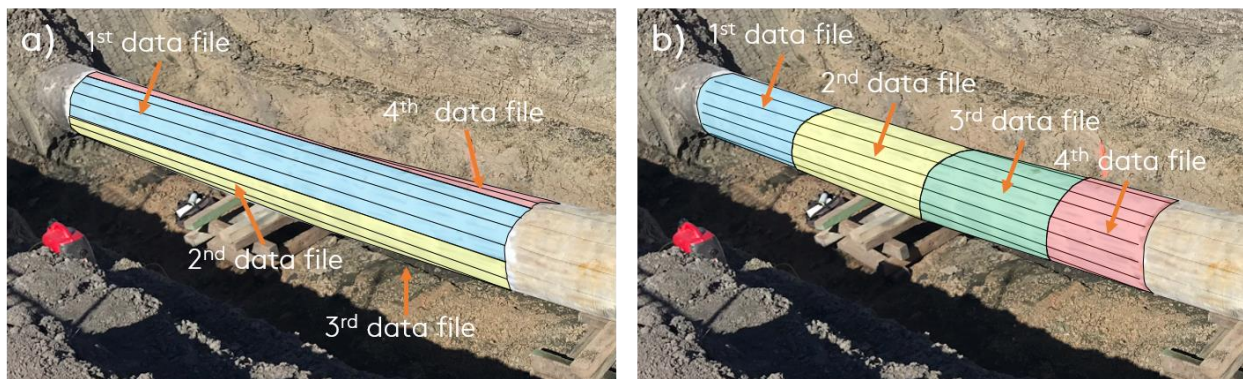

Figure 19. a) Orientation-based division of the surface, with each data file covering the entire length of the pipe and containing 4 passes (90°) of 8 meters; b) Length-based division of the surface, with each data file covering the entire circumference of the pipe and containing 16 passes (360°) of 2 meters.

## 8c. Spyne keypad

The Spyne keypad can be used to facilitate the acquisition. Note that the *Previous Pass* button is only active when using an Ectane and is not associated to any action on Reddy.

The red LED is currently unused. Work is undergoing to eventually use this LED as a real-time alarm for the detection of indications.

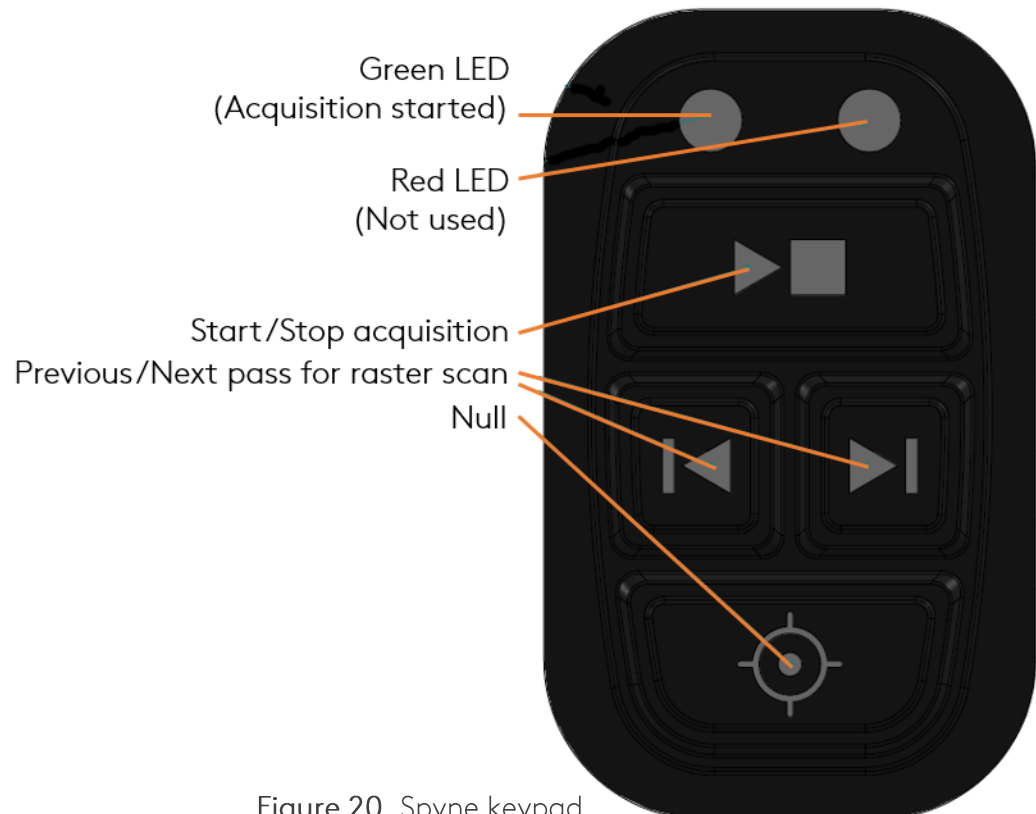

Figure 20. Spyne keypad

## 8d. Limitations

The data acquisition with the Spyne is subject to the following limitations:

- o The maximum scan speed is limited to 600 mm/s (24 in/s). If the operator wishes to limit the scan speed to a lower value, it can be modified in *Setup* → *Scan*.
- o As explained before, with the Spyne's default scan resolution of 2 samples/mm (50 samples/inch), the maximum scan length for a single pass is approximately 50 meters (2000 inches). For raster scans, the maximum scan length will depend on the number of passes, as presented in the table above. Exceeding this limit may cause incomplete data recording, error notifications or software crashes upon starting the acquisition. Modifying the scan resolution will have a direct effect on the maximum scan length: dividing the scan resolution by 2

(1 sample/mm or 25 sample/inch) will double the maximum scan length allowed (100 meters or 4000 inches), and vice-versa.

- The C-scans are built assuming a continuous and linear scan. While scanning, make sure to roll the Spyne in a straight line, and to keep the encoder in contact with the surface. Missing counts from the encoder will result in an unscanned area and an inaccurate positioning of the indications.
- If the component being inspected doesn't allow for the encoder to roll on a straight surface, clock-based acquisition can be selected in *Setup* → *Scan*. In this case, the scan speed needs to be kept as accurate and constant as possible to allow locating the defects on the surface.
- If the encoder wheel wears out over time and its diameter changes, the measured distance will become inaccurate. To workaroud this issue, the encoder can be calibrated as presented in section 12 of this user guide. Alternatively, since the encoder is detachable, a new one can be purchased from Eddyfi.
- The Spyne is designed to inspect relatively smooth surfaces with limited irregularities. Irregularities such as axial and transverse welds, corrosion, sharp bending, flanges, etc. can cause additional lift-off during the acquisition. Depending on the orientation of the lift-off curve (section 5) and on the adjustment of the detection threshold (section 6), this additional lift-off will cause a certain loss of sensitivity.

## 9. Analysis and reporting

---

### 9a. Indications display

Immediately after the acquisition is stopped, the C-scan will display yellow boxes around all the indications detected, based on the signal threshold set previously (see section 6 of this user guide).

Depending on the amount of overlap between each pass, indications located in the overlapped area between two passes may have been duplicated: this is the price to pay to make sure that no defect is left behind. For single-pass scans, these indications will be present in two separate data files: near the top of the C-scan in one file, and near the bottom of the C-scan in the next or previous file. For raster scans, the duplication will be more obvious: two identical indications will be displayed side-by-side, on the edges of two adjacent passes. Figure 21 below shows an example for a raster scan.

For the same reason, the Y position of an indication displayed in the C-scan will become inaccurate due to the overlap. To locate an indication on the Y axis, its position within a given pass should be used.

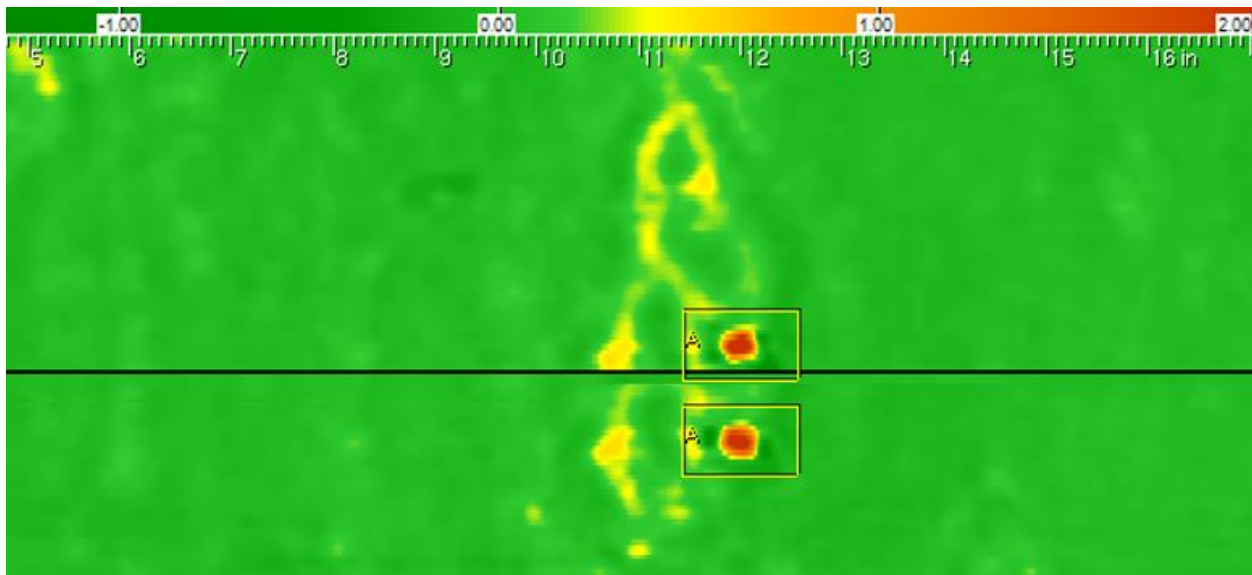

Figure 21. Duplication of an indication in the overlap area of a raster scan. The same indication is displayed on the edge of two adjacent scan passes.

## 9b. Indications merging criteria

Before adding all the indications to the report, it may be relevant to review the boundary criteria for merging indications close to each other. For example, in most situations, it would be irrelevant to report dozens of separate indications within a single colony of cracks. Merging all these small indications into a single indication would be more appropriate and would lead to a lighter report. This is also more consistent with how visual inspection is performed. The boundary criteria for the X and Y axes can be modified in the *Detect Indications* menu. By default, one sample in X corresponds to 0.5 mm (0.020"). For example, setting the X boundary criterion to 40 samples means that two indications within 20 mm (0.80") of each other in the X axis will merge together. In the Y axis, one sample corresponds to 1.6 mm (0.063") for probes with 66 coils, and to 1.2 mm (0.047") for probes with 86 coils.

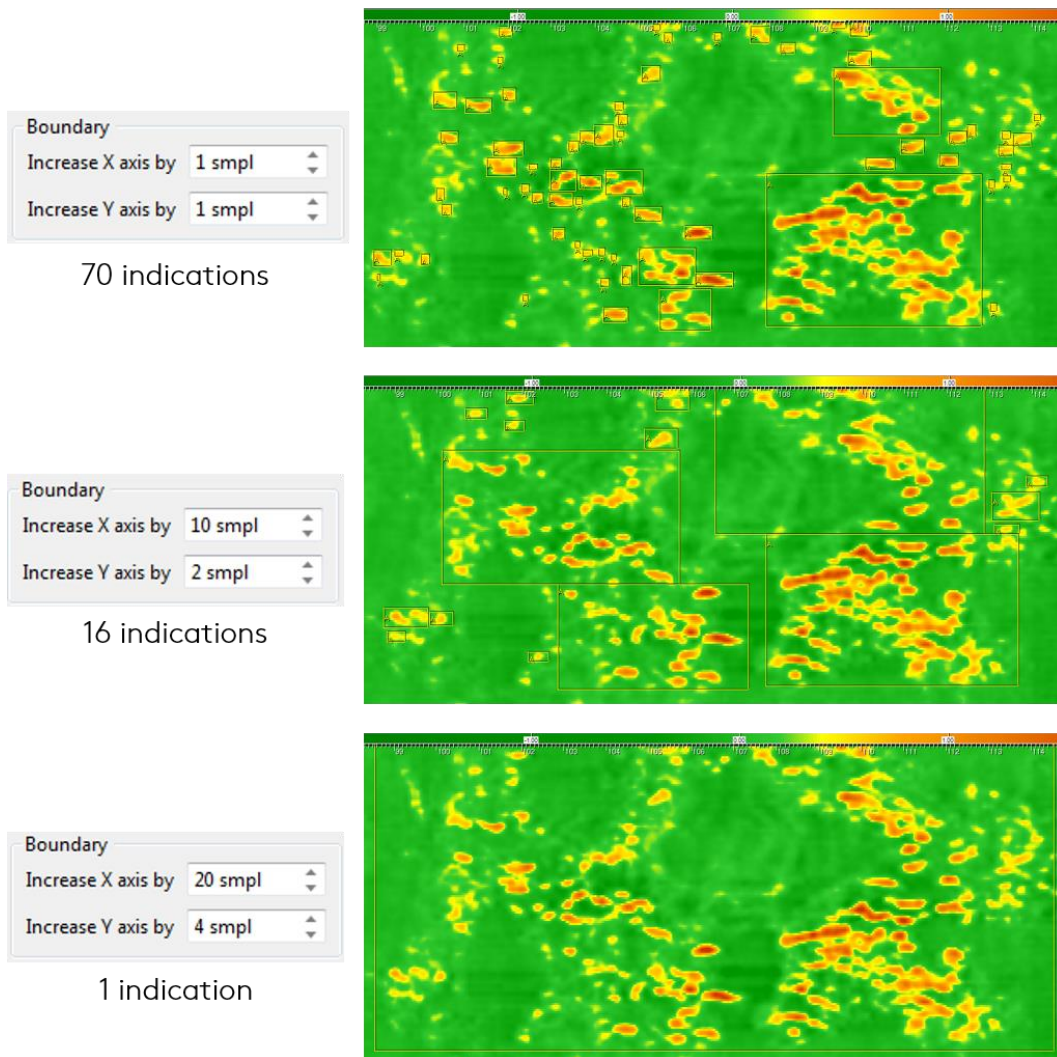



Figure 22. Effect of the X and Y boundary criteria on the number of indications displayed in the C-scans. Optimizing the boundary values will have a direct effect on the relevance of the report.



## 9c. Building the report



At any time during an inspection, the content of the report can be visualized and modified in the *Report* tab at the bottom of the screen. If this tab is not displayed, first make sure that *Report* is selected in the *Layout* menu.

Since the report format is often specific to the inspection procedure being followed, the aim of this section is not to suggest a specific report format, but rather to present all the tools available in Magnifi for building a report. All the following tools can be accessed in the *Analysis* tab:





- 
 The *Report Detections* button will add to the report every single indication marked with a yellow box in the C-scan, based on the current automatic detection threshold. The position and size (X and Y) of each indication will be reported. This is where the boundary criteria presented in section 9a becomes important: a report with 20 merged indications will be a lot easier to consult compared to a report with 500 smaller indications all gathered close to each other.

- 
 Similarly, the *Remove Detections* button will remove all these indications from the report in one click.

- 

 The *Previous* and *Next* buttons are used to navigate between the different indications in the C-scans, based on their position on the X axis. By default, the keyboard shortcuts for *Previous* and *Next* are F7 and F8.

- If the automatic detection tools are not used or if additional indications need to be added to the report manually, use the *Add defect*   buttons at the bottom of each Lissajous view. This will add a yellow indication box in the corresponding C-scan, where the cursor is located. Additionally to the X-Y position of the indication, the amplitude (V) and phase (°) of the eddy current signal measured in the impedance plane will also be reported. These indications reported manually are independent from the automatic detection threshold, and will not be removed from the report by clicking on *Remove Detections*. The option to take a screenshot for every indication added manually is available in the backstage: these screenshots can also be added to the report.

All indications, reported either automatically or manually, will all appear in the same report.

- o The *No Defect*  button is used to tag a data file without any indication.
- o The *Review*  button is used to tag a data file for further review.
- o The *Add Note*  button creates a .txt file attached to the data file currently loaded.
- o The *Capture*  button takes a .png screen capture attached to the data file currently loaded.

## 9d. Generating the report

For Spyne and ECA in general, Magnifi offers two types of report format, available in the report's *Table Profile* option in the backstage:

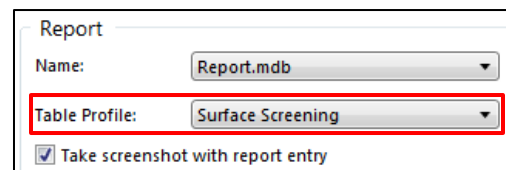

- o Surface Screening: ideal format for the indications reported with the automatic detection tools (i.e. the *Report Detections* button). The screening report contains the position and size (X and Y) of each indication.
- o Generic Array: ideal format for the indications reported manually (i.e. with the *Add defect* buttons). The generic array report will contain the position (X and Y), signal amplitude (V) and signal phase (°) of each indication.



Once the table profile has been selected, click on *Generate Report* to generate the report. After selecting the report options and filling out the information contained in the report summary, the report will be displayed on the screen:

- The first page contains the report summary;
- The second page contains the defect table, with all the reported indications;
- If indications were reported manually with screenshots, the screenshots will be displayed at the end of the report.

The report can be exported into .pdf, .doc or .xls format. The exported file will be saved in the inspection folder, which can later be transferred through wi-fi or USB key by clicking on *Transfer Inspection*.





## 10. High-pass median filters

The high-pass median filter is a powerful tool that increases the signal-to-noise ratio of ECA data and facilitates crack detection. However, if used the wrong way, it can filter out certain defects and make them invisible in the C-scan.

The high-pass median filter can be tuned in the *Process* menu  of the *Setup* tab.

The *Index Axis* value is used for two-dimensional median filters, which are rarely beneficial for the detection of surface-breaking defects such as cracks and pittings. For this reason, the *Index Axis* should be kept to its default value.

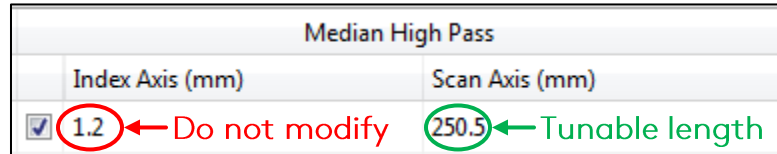

The important tunable parameter of the high-pass median is the *Scan Axis* value. A widely used rule of thumb is to set this value to three times the longest expected defect. For example, in the presence of stress corrosion cracking colonies that can be as long as 100 mm (4 inches) in the scan axis, a filter of 300 mm (12 inches) should be used. Since it is often difficult to predict the size of the defects before an inspection, the length of the median filter should initially be kept to a high value.

In summary, as displayed in Figure 23 below, an excessively long filter will not be as efficient in removing the background noise, but an excessively short filter will remove part of the signal from the defects.

After data has been acquired, clicking on *Lift-off Assist*. in the *Calibration* tab will temporarily disable all median filters. This can be used as a quick on/off filter toggle.

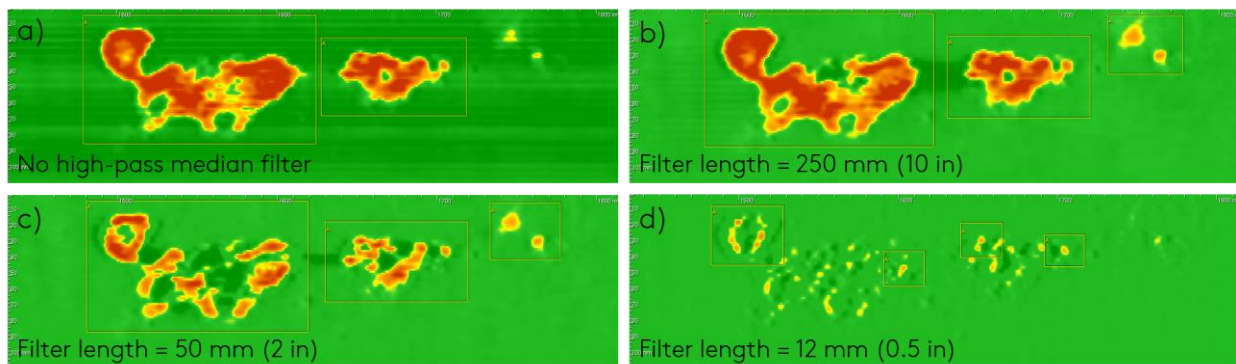

Figure 23. Effect of the size of a high-pass median filter on data quality: a) no filter causes a higher background noise (dark horizontal lines) and the smaller indications in the top right corner being missed; b) an optimal filter size provides an enhanced signal-to-noise ratio for indications of all sizes; c) a filter that is slightly too short removes parts of large indications without affecting their detectability; d) a filter that is significantly too short removes most of the indications and leads to defects being missed entirely.

## 11. Detection of hard spots

A hard spot is an area of material that has experienced a local increase of hardness, caused either by cold work or by quenching during the manufacturing process. Since this localized hardening is associated with changes of the magnetic properties of the material, the Spyne can be used to detect them efficiently.

Most of the content presented in this user guide still applies to the detection of hard spots, with two extra steps required before beginning the inspection:

- 1) Change the color palette to *Dark Rainbow*;
- 2) Disable the high-pass median filters in the *Process* menu.

Hard spots indications are associated with a negative variation of signal amplitude in both the axial and transverse channels, with a phase shift of approximately  $180^\circ$  relatively to crack indications. Since the default color palette used with the Spyne offers poor contrast for negative signals, it is highly beneficial to use an alternative color palette such as *Dark Rainbow* (Magnifi 4.7) or *Saw Tooth Rainbow* (previous versions). This can be done in the *Palette* menu of the *Current View* tab.

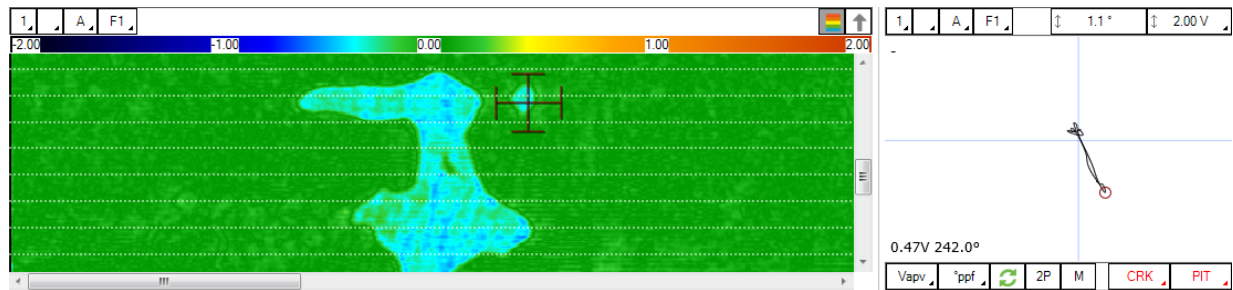

Figure 24. Two distinct hard spots displayed in blue by using the *Dark Rainbow* color palette. The C-scan cursor shows the hard spot's negative signal signature in the Lissajous window.

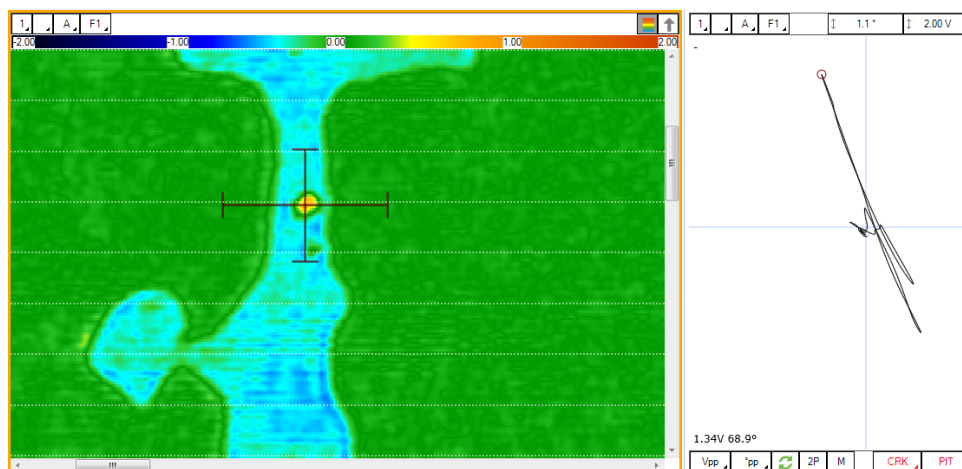

Figure 25. Small colony of SCC in the middle of a hard spot: the *Dark Rainbow* palette displays the SCC in orange (positive impedance signal) and the hard spot in blue (negative signal).

It is also important to have a good understanding of the high-pass median filters presented in section 10, since the size of a hard spot can be significantly larger than most colonies of cracks. As a result, a median filter of small size can remove entirely a hard spot from the C-scans. For the detection of hard spots, it is good practice to initially disable the high-pass median filter, and enable it only during the analysis phase with a size adjusted based on the hard spots indications that were detected.

Refer to section 10 for more details on the high-pass median filter.

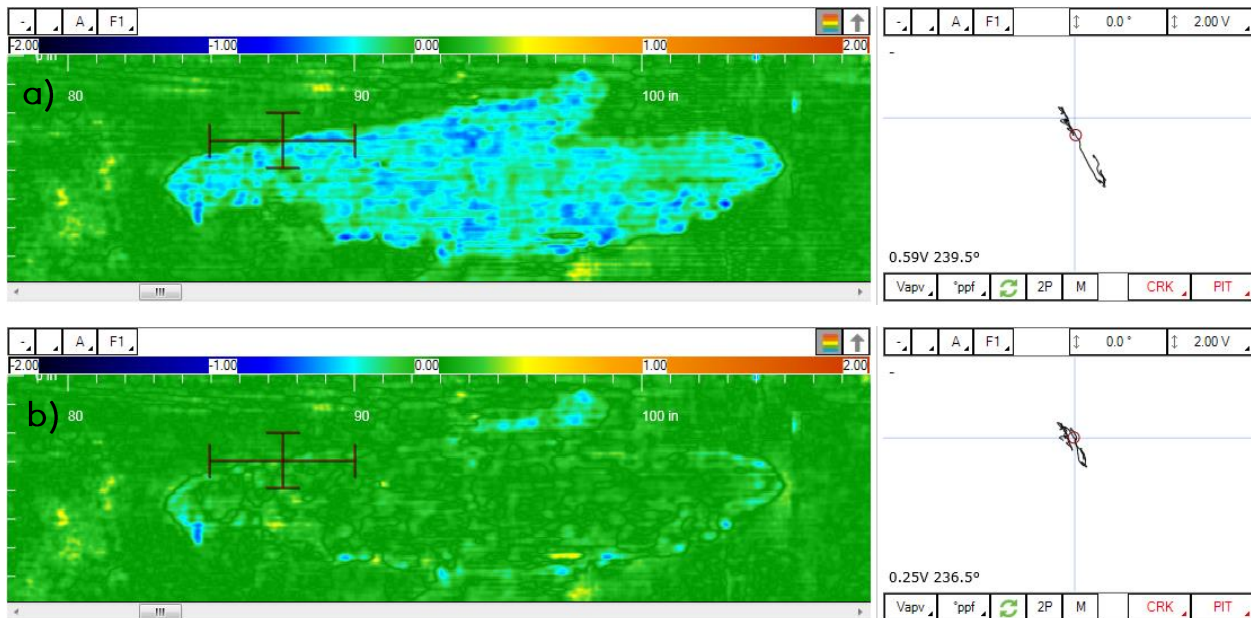

Figure 26. Oval-shaped hard spot indication of approximately 530 mm by 150 mm (21 in by 6 in) displayed with a) an extra-long high-pass median filter of 2500 mm (100 in) and b) the default median filter used for SCC detection, with a size of 250 mm (10 in). In the second case, most of the hard spot signature is removed by the filter.

Finally, to add a hard spot indication to the report, the indication code HS (hard spot) can be used instead of the standard CRK and COR (crack and corrosion) by holding the *Add defect* button at the bottom of the Lissajous window. The indication codes can be managed in the *Indication* menu of the *Setup* tab.

## 12. Encoder calibration

---

If the encoder wheel wears in time, its diameter can change and affect the encoder's resolution. This will in turn affect the length measurement and positioning of indications, and might distort the transverse C-scan (i.e. causing a straight transverse indication to appear with a zigzag shape in the transverse C-scan).

To workaroud this issue, a simple calibration can be performed to apply a correction factor to the encoder's resolution:

- I) Start an acquisition.
- II) Roll the Spyne in a straight line on a flat surface, and stop the acquisition. A longer travel distance will lead to a more precise calibration.
- III) Measure the traveled distance precisely.
- IV) In the *Calibration* menu, click on the *Encoder*  calibration button.
- V) Enter the measured traveled distance and click *Enter*.
- VI) Click *Calibrate* and click *OK*. The correction factor is now applied to the setup configuration.